

PRODUCT DESIGN & PROFILE SCHEDULE

GEOMETRIC PANELS

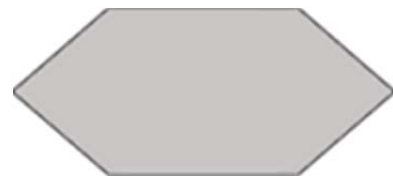
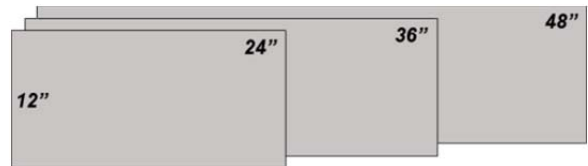
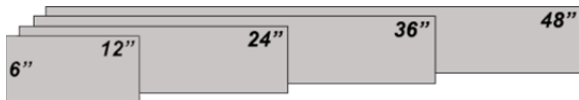
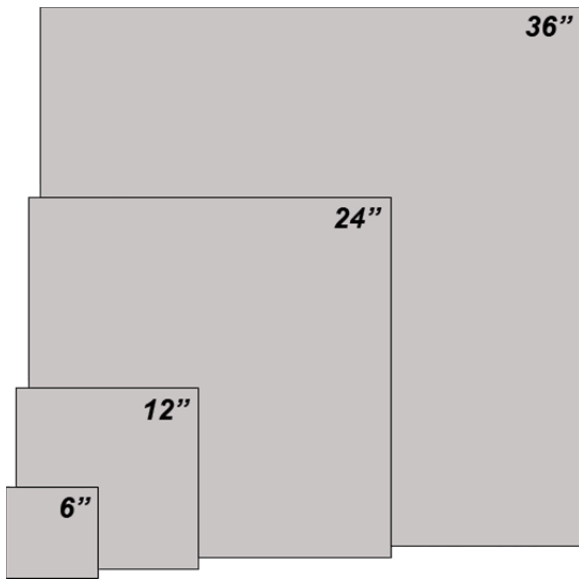

NOT TO SCALE

INSTALLATION PATTERNS

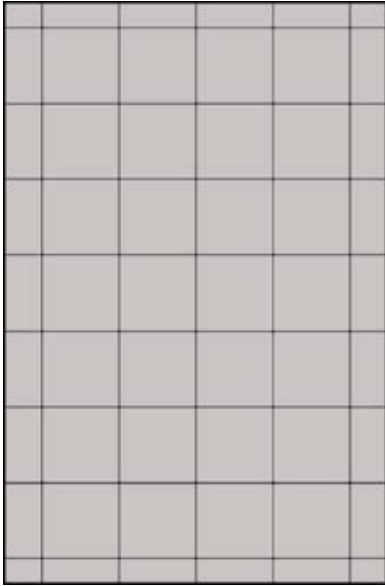

Grid

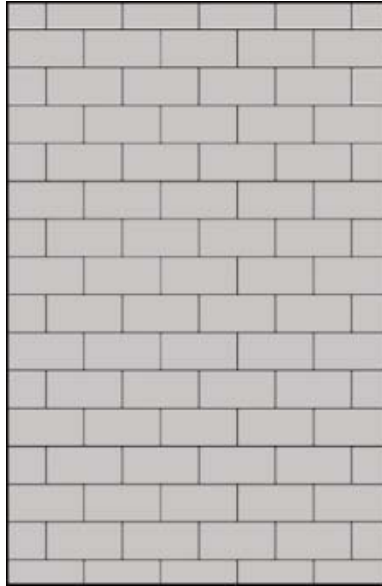

Running Bond

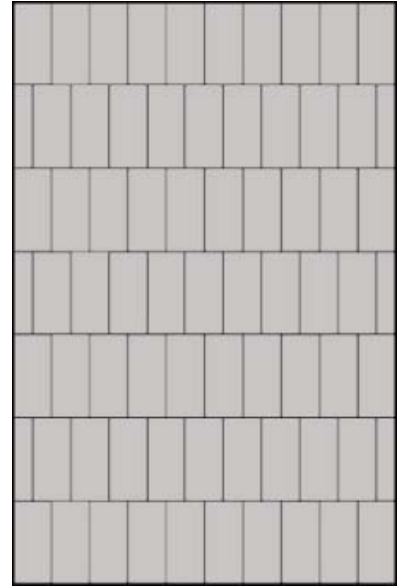

*Vertical Running
Bond*



Diagonal Bond

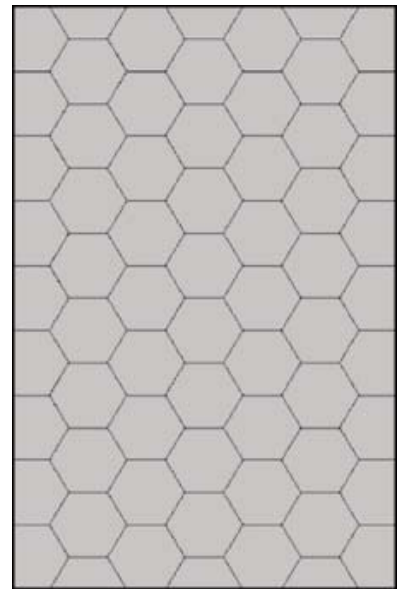

Hexagonal

ADDITIONAL PATTERNS ARE AVAILABLE UPON REQUEST

WALL PRODUCTS

WALLBASE Cross Section View

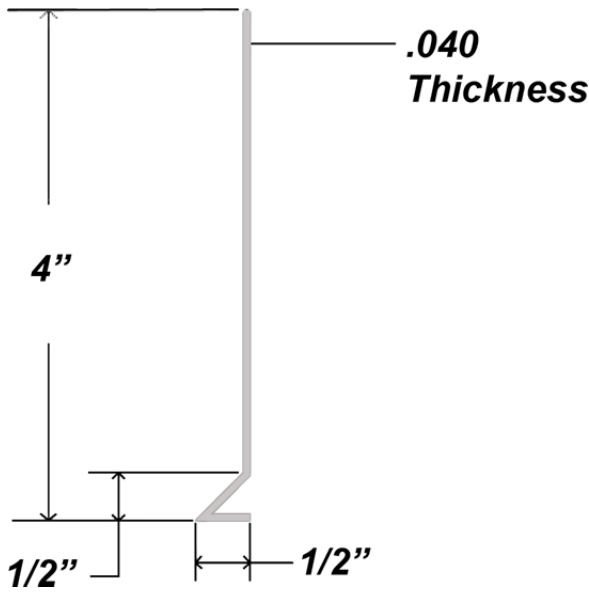

NOT TO SCALE

Outside Corner Option

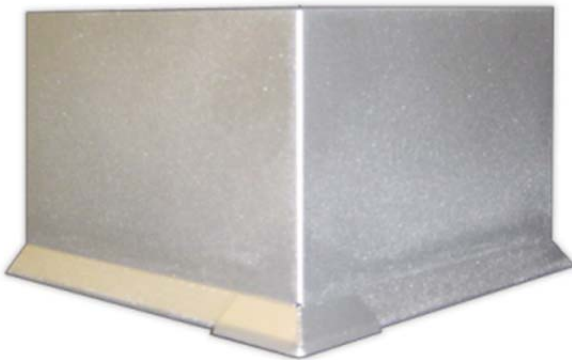

NOT TO SCALE

- For Interior Usage
- Clear Coat Anodized Aluminum in a Matte Finish
- Available Colors:
 - Standard - Clear Coat
 - Optional - Black
 - Optional - Titanium
(MEDIUM HIGH SHADING)
- #5052 Aluminum Alloy
- Standard Size
 - 4" or 6" tall
 - 47.75" long
 - .040" thick
- Not Suitable for Curved or Radius Walls
- Sold per piece
- Optional Outside Corner Available

STAIR PRODUCTS

STANDARD TREAD

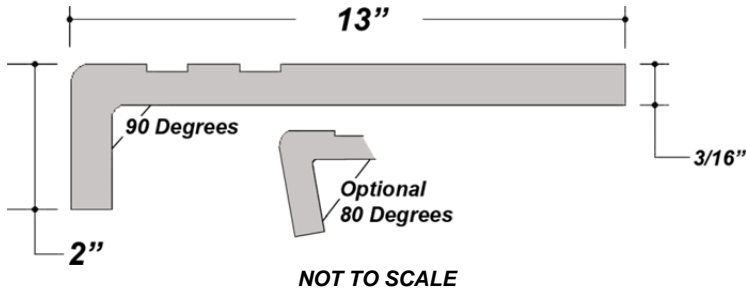

- For Interior Usage
- Clear Coat Anodized Surface
- Available Colors:
 - Clear Coat
 - Black
 - Titanium

OVERLAP TREAD

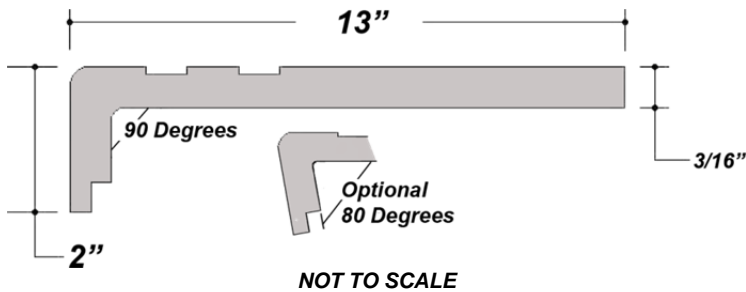

- 3/16" #5052 Aluminum Alloy
- Available in Lengths of 4' to 7'
- Features Routed Safety Edge
- Choose Standard 90 Degree Bend to 80 Degrees

STAIR RISER

*AVAILABLE WITH OVERLAP ALSO

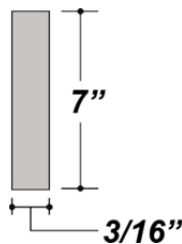

- Matching Riser Available in 4' to 7' Lengths
- Overlap Joining Available for both Stair Treads and Risers

FASTENING

Apply APAC #U989 to back of tread and step. Weight down tread for best results. Tread may be fastened with screws – drill and countersink.

TACTILE WARNING SYSTEM

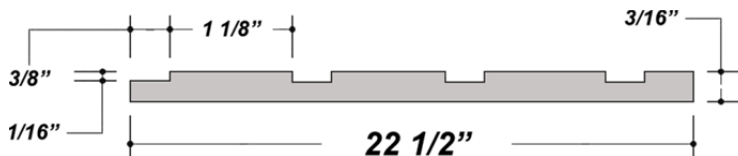

NOT TO SCALE